

Safety directional valves with spool position monitoring

On-off, direct operated, conforming to Machine Directive 2006/42/EC - certified by

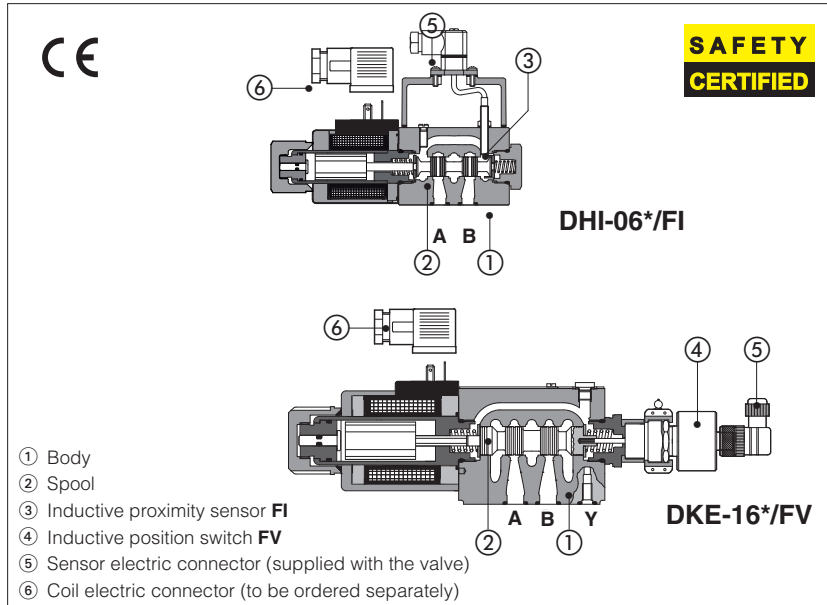

DHI/FI and DHI/FV are phase-out components not recommended for new applications



Direct operated safety directional valves with spool position monitoring, **CE** marked and certified by **TÜV** in accordance with safety requirements of Machine Directive 2006/42/EC.

DHI, size 06, for AC and DC supply, with cURus certified solenoids

DHE, size 06, high performances, for AC and DC supply with cURus certified solenoids

DKE, size 10, for AC and DC supply with cURus certified solenoids

The valves are equipped with **FI** inductive proximity sensor or **FV** inductive position switch for the spool position monitoring, see section [1](#) and [11](#) for sensors availability and technical characteristics.

Certification

The **TÜV** certificate can be downloaded from www.atos.com, catalog on line, technical information section.

Mounting surface: **ISO 4401**, size **06** and **10**

Max flow: **DHI 60 l/min**

DHE 80 l/min

DKE 150 l/min

Max pressure: **350 bar**

1 RANGE OF VALVE'S MODELS

Valve code	Size	Description	DC solenoids		AC solenoids	
			/FI	/FV	/FI	/FV
DHI-06	06	direct operated solenoid valves, on-off, single solenoid	•	•	•	•
DHI-07	06	direct operated solenoid valves, on-off, double solenoid	•		•	
DHE-06	06	direct operated solenoid valves, on-off, single solenoid	•	•	•	•
DHE-07	06	direct operated solenoid valves, on-off, double solenoid	•	•	•	
DKE-16	10	direct operated solenoid valves, on-off, single solenoid	•	•	•	•
DKE-17	10	direct operated solenoid valves, on-off, double solenoid	•	•	•	

Notes:

FI = inductive proximity sensor, type NO (normally open) or NC (normally closed)

FV = inductive position switch providing both NO and NC contacts to be wired on the electric connector

See section [11](#) for sensor's characteristics

1.1 FI sensor & FV switch configurations

Single solenoid valves size 06 & 10 are provided with n°1 FI sensor or n° 1 FV switch for the spool position monitoring

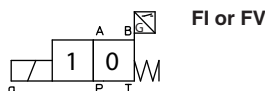

Double solenoid valves size 06 & 10 are provided with n° 2 FI sensors or n° 1 FV switch for the spool position monitoring

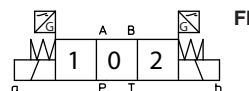

Double solenoid valves size 06 with detent are provided with n°2 FI sensors or n° 1 FV switch for the spool position monitoring

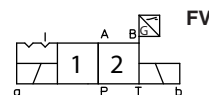
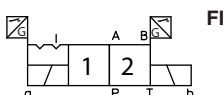

Double solenoid valves size 10 with detent are provided with n° 1 FI sensor or n° 1 FV switch for the spool position monitoring

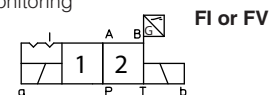

For model code of **DHI** and **DHE** safety valves, see section [2](#)

For model code of **DKE** safety valves, see section [4](#)

2 MODEL CODE OF DHI AND DHE

DHI	- 0	63	1/2	/ A	/ FV	* - X	24DC	**	/ *
Directional control valve size 06 DHI = max flow 60 l/min DHE = max flow 80 l/min Size ISO 4401 0 = size 06 Valve configuration , see section 3 61 =single solenoid, central plus external position, spring centered 63 =single solenoid, 2 external positions, spring offset 67 =single solenoid, external plus central position, spring offset 71 =double solenoid, 3 positions, spring centered 75 =double solenoid, 2 external positions, with detent Spool type , see section 3 Options , see section 8								Seals material see sect. 6,7 - = NBR PE = FKM Series number Voltage code , see section 9 X = without connector, see section 10 for available connectors, to be ordered separately Electrical signal - only for FI version (1): /NC = electric contact is closed when the valve is de-energized /NO = electric contact is open when the valve is de-energized	
Spool position monitor: FI = inductive proximity switch FV = inductive position switch (double contact)									

(1) the **FV** inductive position switch provides both NC and NO contacts

3 CONFIGURATIONS AND SPOOLS FOR DHI AND DHE (representation according to ISO 1219-1)

Configurations	Spools				Configurations	Spools	
61 61/A 67 67/A 71 (for valves /FV) 71 (for valves /FI)	1 0 4 8 19 49 1/9 (2) 7/7 (1)	2 5 90 16 2/7 (1)	3 6 09 39 17 5/7 (1)	1 0 2 1/9 (1)	63 63/A 75 (for /FI) 75 (for /FV)	0/2 1/2 2/2 1 0/2 1/2	
(1) only for configuration 61, not available for configuration 61/A (2) only for DHI-0711/9/FI and DHE-0711/9/FI							

3.2 Special shaped spools for DHI and DHE

- spools type **0** and **3** are also available as **0/1** and **3/1** with restricted oil passages in central position, from user ports to tank.
- spools type **1**, **4**, **5** and **58** are also available as **1/1**, **4/8**, **5/1** and **58/1**. They are properly shaped to reduce water-hammer shocks during the swithing.
- spools type **1**, **1/2**, **3**, **8** are available as **1P**, **1/2P**, **3P**, **8P** to limit valve internal leakages.
- Other types of spools can be supplied on request.

3.1 Standard spool availability for DHI and DHE - spools not listed in the table are available for all valves models









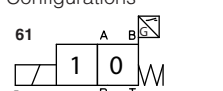
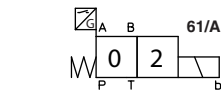
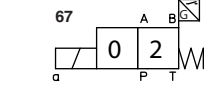
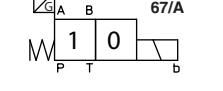
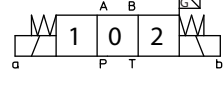
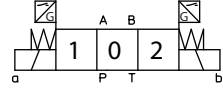
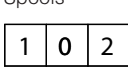
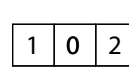
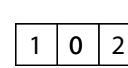
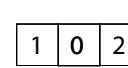
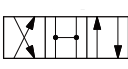
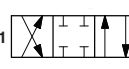
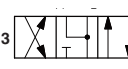
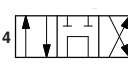
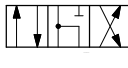

Valve type	standard spool						
	09	90	39	93	49	94	1/9
DHI/FI	•	•	•	•	•	•	•
DHI/FV							
DHE/FI	•	•	•	•	•	•	•
DHE/FV							

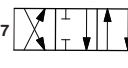
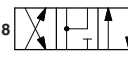
4 MODEL CODE OF DKE

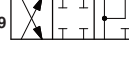
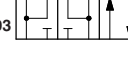
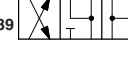
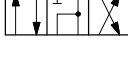
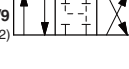
DKE	- 1	63	1/2	/ A	/ FV	* - X	24DC	**	/ *	
Directional control valve size 10 Size ISO 4401 1 = size 10 Valve configuration , see section 5 61 =single solenoid, central plus external position, spring centered 63 =single solenoid, 2 external positions, spring offset 67 =single solenoid, external plus central position, spring offset 71 =double solenoid, 3 positions, spring centered 75 =double solenoid, 2 external positions, with detent Spool type , see section 5 Options , see section 8							Seals material see sect. 6,7 - = NBR PE = FKM Series number Voltage code , see section 9 X = without connector, see section 10 for available connectors, to be ordered separately			
							Electrical signal - only for FI version (1): /NC = electric contact is closed when the valve is de-energized /NO = electric contact is open when the valve is de-energized			
							Spool position monitor: FI = inductive proximity switch FV = inductive position switch (double contact)			

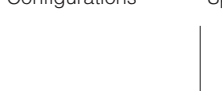
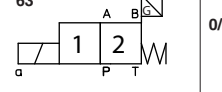
DKE/FI and /FV are always provided with Y drain port
(1) the **FV** inductive position switch provides both NC and NO contacts

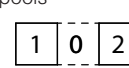
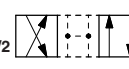
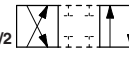
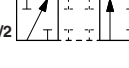
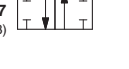
5 CONFIGURATIONS AND SPOOLS FOR DKE (representation according to ISO 1219-1)

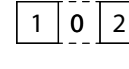
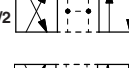
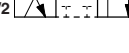
Configurations	Spoils	Configurations	Spoils
61  61/A  67  67/A  71 (for valves /FV)  71 (for valves /FI) 	    0  1  3  4  5  6  7  8  91  19  93  39  58  1/9 (2)  1/3 (1)  7/7 	63  63/A  75 	 0/2  1/2  2/2  2/7 (3)  5/7 (3)   0/2  1/2 

(1) only for DKE-1611/3/*DC
 (2) only for DKE-1711/9/FI
 (3) only for configuration 63, not available for configuration 63/A

5.1 Special shaped spools for DKE

- spools type **0** and **3** are also available as **0/1** and **3/1** with restricted oil passages in central position, from user ports to tank.
- spools type **1** is also available as **1/1**, properly shaped to reduce the water-hammer shocks during the switching.
- spool type **1/9** has closed center in rest position but it avoids the pressurization of A and B ports due to the internal leakages.
- other types of spools can be supplied on request.

6 MAIN CHARACTERISTICS

Assembly position / location	Any position		
Subplate surface finishing	Roughness index Ra 0,4 - flatness ratio 0,01/100 (ISO 1101)		
MTTFd values according to EN ISO 13849	150 years, for further details see technical table P007		
Compliance	CE to Machine Directive 2006/42/EC. -EC type-examination certificate for safety components (1) -ISO 13849 category 1, PLC in high demand mode CE to Low Voltage Directive 2014/35/EU and Machine Directive 2006/42/EC. RoHS Directive 2011/65/EU as last update by 2015/65/EU REACH Regulation (EC) n°1907/2006		
Ambient temperature	Standard = -30°C ÷ +70°C /PE option = -20°C ÷ +70°C		
Flow direction	As shown in the symbols of table 3 and 5		
Operating pressure	DHI	P, A, B = 350 bar T = 100 bar (version /FI); 120 bar (version /FV)	
	DHE	P, A, B = 350 bar T = 100 bar (version /FI); 210 bar (DC solenoid - version /FV); 160 bar (AC solenoid - version /FV)	
	DKE	P, A, B = 350 bar T = (with Y port not connected to tank) 100 bar (version /FI); 210 bar (DC solenoid - version /FV); 120 bar (AC solenoid - version /FV) T = (with Y port drained to tank) 250 bar	
Rated flow	see diagrams Q/Δp at section 14		
Maximum flow	DHI	60 l/min see section 15	
	DHE	80 l/min see section 15	
	DKE	150 l/min see section 15	

(1) The type-examination certificate can be download from www.atos.com

6.1 Coils characteristics

Insulation class	H (180°C) for DC coils (all versions) and AC coils (only DHI) F (155°C) for AC coils (DHE, DKE) Due to the occurring surface temperatures of the solenoid coils, the European standards EN ISO 13732-1 and EN ISO 4413 must be taken into account
Protection degree to DIN EN 60529	IP 65 (with connectors correctly assembled)
Relative duty factor	100%
Supply voltage and frequency	See electric features 9
Supply voltage tolerance	± 10%
Certification	cURus North American standard

7 SEALS AND HYDRAULIC FLUID - for other fluids not included in below table, consult our technical office

Seals, recommended fluid temperature	NBR seals (standard) = -20°C ÷ +80°C, with HFC hydraulic fluids = -20°C ÷ +50°C FKM seals (/PE option) = -20°C ÷ +80°C			
Recommended viscosity	15 ÷ 100 mm ² /s - max allowed range 2,8 ÷ 500 mm ² /s			
Max fluid contamination level	ISO4406 class 20/18/15 NAS1638 class 9, see also filter section at www.atos.com or KTF catalog			
	Hydraulic fluid	Suitable seals type	Classification	Ref. Standard
Mineral oils	NBR, FKM	HL, HLP, HLPD, HVLP, HVLPD	ISO 12922	
Flame resistant without water	FKM	HFDD, HFDR		
Flame resistant with water	NBR	HFC		

8 OPTIONS

A = Single solenoid valves: solenoid mounted at side of port B. In standard versions the solenoid is mounted at side of port A.

Double solenoid valves DHE/FV(DC), DKE/FV(DC): FV inductive position switch mounted at side of port A. In standard versions the position switch is mounted at side of port B.

WARNING: the manual operation is not permitted for safety valves, than the valve is provided with solenoid blind rings to prevent the access to the manual override. The manual override protected by rubber cup (option /WP) is not available



WARNING: the inobservance of following prescriptions invalidates the certification and may represent a risk for personnel injury

Safety valves must be installed and commissioned only by qualified personnel

Safety valves must not be disassembled

The inductive proximity FI or the inductive position switch FV can be adjusted only by the valve's manufacturer or Atos authorized service centers

Valve's components cannot be interchanged

The valves must operate without switching shocks and spool vibrations



9 ELECTRIC FEATURES

9.1 COILS FOR DHI AND DHE VALVES

Valve	External supply nominal voltage $\pm 10\%$	Voltage code	Type of connector	Power consumption (3)		Code of spare coil				
				DHI	DHE	DHI	Colour of coil label	DHE		
DHI DHE	6 DC	6 DC (4)	666 or 667	33 W	30 W	COU-6DC	brown	-		
	12 DC	12 DC				COU-12DC	green	COE-12DC		
	14 DC	14 DC				COU-14DC	brown	COE-14DC		
	24 DC	24 DC				COU-24DC	red	COE-24DC		
	28 DC	28 DC				COU-28DC	silver	COE-28DC		
	48 DC	48 DC				COU-48DC	silver	COE-48DC		
	110 DC	110 DC				COU-110DC	gold	COE-110DC		
	125 DC	125 DC				COU-125DC	blue	COE-125DC		
	220 DC	220 DC				COU-220DC	black	COE-220DC		
	24/50 AC	24/50/60 AC (4)				60 VA	-	COI-24/50/60AC (1)	pink	-
	24/60 AC		COI-48/50/60AC (1)	white	-					
	48/50 AC	48/50/60 AC (4)	60 VA	-	58 VA	COI-110/50/60AC (1)	yellow	COE-110/50/60AC		
	48/60 AC				80 VA	-	COE-115/60AC			
	110/50 AC	110/50/60 AC	-	-	60 VA	58 VA	COI-120/60AC	white	-	
	115/60 AC (5)	115/60 AC			80 VA	COI-230/50/60AC (1)	light blue	COE-230/50/60AC		
	120/60 AC (4)	120/60 AC	60 VA	-	58 VA	COI-230/60AC	silver	COE-230/60AC		
	230/50 AC	230/50/60 AC			80 VA	COU-110RC	gold	COE-110RC		
	230/60 AC	230/60 AC	669	33 W	30 W	COU-230RC	blue	COE-230RC		
	110/50 AC	110RC				-	-	-	-	-
	120/60 AC									
230/50 AC										
230/60 AC	230RC									

(1) Coil can be supplied also with 60 Hz of voltage frequency: in this case the performances are reduced by 10÷15% and the power consumption is 55 VA (DHI) and 58 VA (DHE)

(2) Average values based on tests performed at nominal hydraulic condition and ambient/coil temperature of 20°C.

(3) When solenoid is energized, the inrush current is approx 3 times the holding current. Inrush current values correspond to a power consumption of about 150 VA.

(4) Only for DHI

(5) Only for DHE

9.2 COILS FOR DKE VALVE

External supply nominal voltage $\pm 10\%$	Voltage code	Type of connector	Power consumption (2)	Code of spare coil	
12 DC	12 DC	666 or 667	36 W	CAE-12DC	
14 DC	14 DC			CAE-14DC	
24 DC	24 DC			CAE-24DC	
28 DC	28 DC			CAE-28DC	
110 DC	110 DC			CAE-110DC	
125 DC	125 DC			CAE-125 DC	
220 DC	220 DC			CAE-220DC	
110/50/60 AC	110/50/60 AC			100 VA (3)	CAE-110/50/60AC (1)
230/50/60 AC	230/50/60 AC			130 VA (3)	CAE-230/50/60AC (1)
115/60 AC	115/60 AC			669	36 W
230/60 AC	230/60 AC	CAE-230/60AC			
110/50/60 AC	110 DC	CAE-110DC			
230/50/60 AC	220 DC			CAE-220DC	

(1) In case of 60 Hz voltage frequency the performances are reduced by 10÷15% and the power consumption is 90 VA

(2) Average values based on tests performed at nominal hydraulic condition and ambient/coil temperature of 20°C.

(3) When solenoid is energized, the inrush current is approx 3 times the holding current.

10 COILS ELECTRIC CONNECTORS - according to din 43650 (to be ordered separately)

666, 667 (for AC or DC supply)		669 (for AC supply)		CONNECTOR WIRING		
				666, 667 1 = Positive ⊕ 2 = Negative ⊖ ⊕ = Coil ground		669 1,2= Supply voltage VAC 3 = Coil ground
SUPPLY VOLTAGES						
666 All voltages		667 24 AC or DC 110 AC or DC 220 AC or DC		669 110/50 AC 110/60 AC 230/50 AC 230/60 AC		

11 TECHNICAL CHARACTERISTICS OF INDUCTIVE PROXIMITY AND POSITION SWITCHES

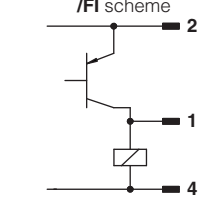
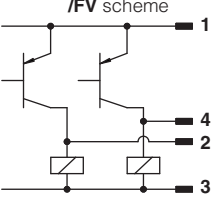
Type of switch	/FI proximity sensor		/FV position switch	
Supply voltage [V]	10÷30		20÷32	
Ripple max [%]	≤ 20		≤ 10	
Max current [mA]	200		400	
Max peak pressure [bar]	100		400	
Mechanical life	virtually infinite		virtually infinite	
Switch logic	PNP		PNP	
		1 output signal 2 supply +24 Vdc 4 GND	1 supply +24 Vdc 2 output signal	3 GND 4 output signal

12 CONNECTING SCHEMES OF INDUCTIVE PROXIMITY AND POSITION SWITCHES - FI and FV sensor's connector are always supplied with the valve

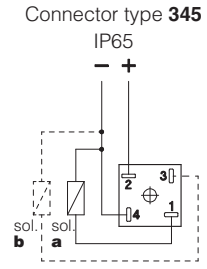
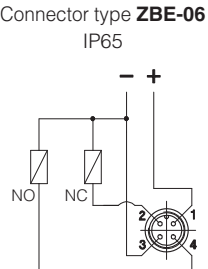
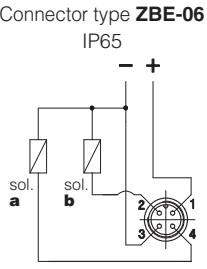
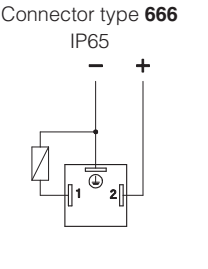
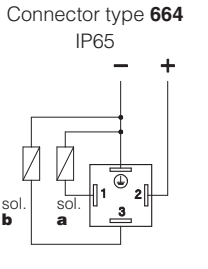
DH*/FI single solenoid / double solenoid (dotted line)	/FV (all valves) single solenoid	/FV (all valves) double solenoid	DKE/FI single solenoid	DKE/FI double solenoid
Connector type 345 IP65	Connector type ZBE-06 IP65	Connector type ZBE-06 IP65	Connector type 666 IP65	Connector type 664 IP65
				
1 = output signal 2 = supply +24 VDC 3 = output signal for double solenoid 4 = GND	1 = supply +24 VDC 2 = output signal NC 3 = GND 4 = output signal NO	1 = supply +24 VDC 2 = output signal sol. b 3 = GND 4 = output signal sol. a	1 = output signal S 2 = supply +24 VDC ⊕ = GND	1 = output signal sol. a 2 = supply +24 VDC 3 = output signal sol. b ⊕ = GND

NOTE: the /FI proximity and /FV position switch are not provided with a protective earth connection

13 STATUS OF OUTPUT SIGNAL

13.1 Signal status for FI versions

	Configuration 61 monitored position "0"	Configuration 63 monitored position "1"	Configuration 67 monitored position "2"	Configuration 71 monitored position "0"	Configuration 75 monitored position "2"
HYDRAULIC CONFIGURATION					
spool position	1 0	1 2	0 2	1 0 2	1 2
sensor signal	ON: low level OFF: high level	ON: low level OFF: high level	ON: low level OFF: high level	ON: low level OFF: high level	ON: low level OFF: high level
sensor a signal	ON: low level OFF: high level	ON: low level OFF: high level	ON: low level OFF: high level	ON: low level OFF: high level	ON: low level OFF: high level
sensor b signal	ON: low level OFF: high level	ON: low level OFF: high level	ON: low level OFF: high level	ON: low level OFF: high level	ON: low level OFF: high level

Diagrams show the behaviour of the output signal for inductive switches type **F/NO**.

For inductive switches type **F/NC** the behaviour is opposite (high level signal instead of low level signal and viceversa)

13.2 Signal status for FV versions

	Configuration 61	Configuration 63	Configuration 67	Configuration 71	Configuration 75	
Hydraulic configuration						
spool position	1 0	1 2	0 2	1 0 2	1 2	
pin 2	ON: low level OFF: high level	ON: low level OFF: high level	ON: low level OFF: high level	ON: low level OFF: high level	ON: low level OFF: high level	
pin 4	ON: low level OFF: high level	ON: low level OFF: high level	ON: low level OFF: high level	ON: low level OFF: high level	ON: low level OFF: high level	

Note: FV position switch can be electrically wired by the customer as NO or NC and then the status of the output signal will be in accordance to the selected configuration

 = intermediate spool position corresponding to the hydraulic configuration change

14 Q/ΔP DIAGRAMS based on mineral oil ISO VG 46 at 50°C

DHI

Flow direction Spool type	Flow direction				
	P→A	P→B	A→T	B→T	P→T
0, 0/1	C	C	C	C	
0/2, 1, 1/1, 1/2, 1/9	A	A	A	A	
2, 3, 3/1	A	A	C	C	
2/2, 4, 4/8, 5, 5/1, 58, 58/1, 94	D	D	D	D	A
6, 7, 16, 17	A	A	C	A	
8	C	C	B	B	
09, 19, 90, 91	B	B	A	A	
39, 93	D	D	D	D	

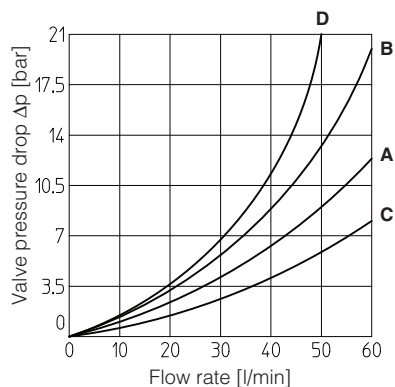

DHE

Flow direction Spool type	Flow direction				
	P→A	P→B	A→T	B→T	P→T
0, 0/1	A	A	C	C	D
1, 1/1, 1/9	D	C	C	C	
3, 3/1	D	D	A	A	
4, 4/8, 5, 5/1, 49, 58, 58/1, 94	F	F	G	C	E
1/2, 0/2	D	D	D	D	
6, 7, 16, 17	D	D	D	D	
8	A	A	E	E	
2	D	D			
2/2	F	F			
09, 19, 90, 91	E	E	D	D	
39, 93	F	F	G	G	

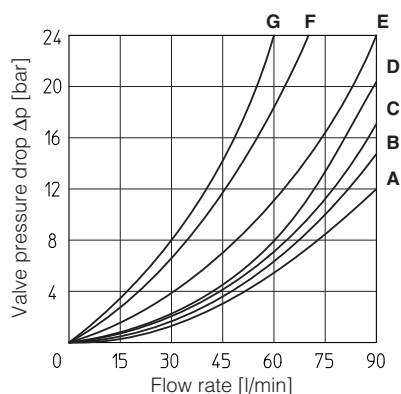

DKE

Flow direction Spool type	Flow direction					
	P→A	P→B	A→T	B→T	P→T	B→A
0, 0/1, 0/2, 2/2	A	A	B	B		
1, 1/1, 1/9, 6, 8	A	A	D	C		
3, 3/1, 7	A	A	C	D		
4	B	B	B	B	F	
5, 58	A	B	C	C	G	
1/2	B	C	C	B		
19, 91	E	E	G	G		H
39, 93	F	F	G	G		H

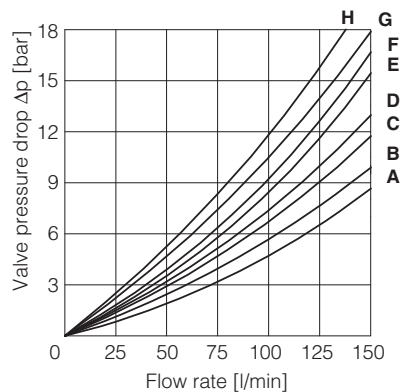

15 OPERATING LIMITS based on mineral oil ISO VG 46 at 50°C

The diagrams have been obtained with warm solenoids and power supply at lowest value ($V_{nom} - 10\%$). The curves refer to application with symmetrical flow through the valve (i.e. P→A and B→T). In case of asymmetric flow and if the valves have the devices for controlling the switching times the operating limits must be reduced.

DHI

Curve	Spool type
A	0, 1, 1/2, 8
B	0/1, 0/2, 1/1, 1/9, 3, 3/1
C	4, 4/8, 5, 5/1, 6, 7, 16, 17, 19, 39, 49, 58, 58/1, 09, 90, 91, 93, 94
D	2, 2/2

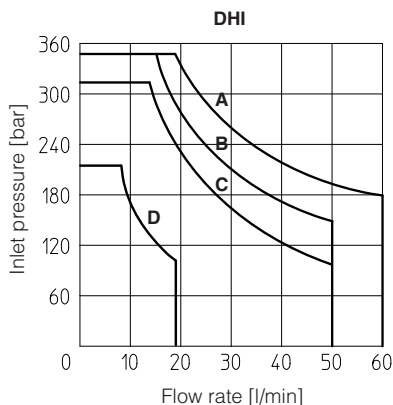

DHE

Curve	Spool type	
	AC	DC
A	1, 1/2, 8	0, 0/1, 1, 1/2, 3, 8
B	0, 0/1, 0/2, 1/1, 1/9, 3	0/2, 1/1, 6, 7, 1/9, 19
C	3, 3/1, 6, 7	3/1, 4, 4/8, 5, 5/1, 16, 17, 19, 39, 49, 58, 58/1, 09, 90, 91, 93, 94
D	4, 4/8, 5, 5/1, 16, 17, 19, 39, 58, 58/1, 09, 90, 91, 93, 94	2, 2/2
E	2, 2/2	-

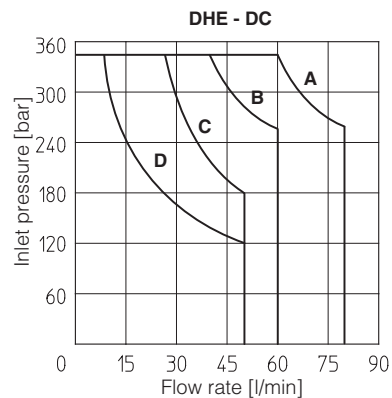
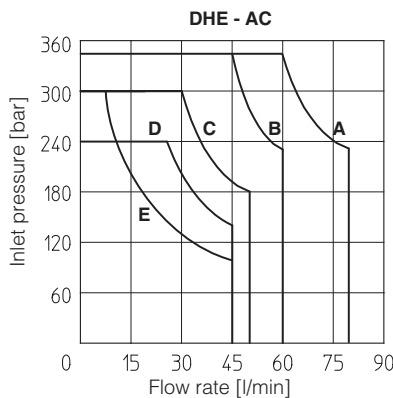

DKE

Curve	Spool type	
	AC	DC
A	0/1	0, 0/1, 1, 1/1, 3, 3/1, 1/2, 0/2, 8
B	4, 5, 19, 91	6, 7
C	0, 1/1, 3, 3/1	19, 91
D	1, 1/2, 0/2	4, 5
E	6, 7, 8, 2/2	2/2

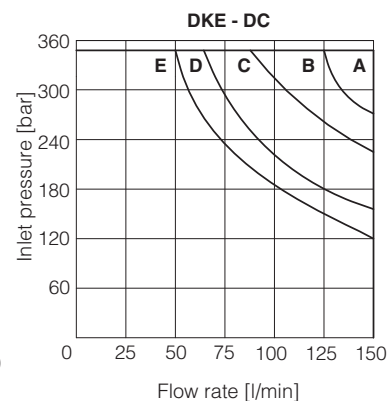
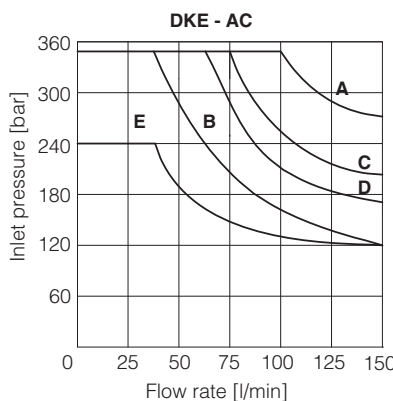

16 DIMENSIONS FOR DHI AND DHE SOLENOID SAFETY VALVES [mm]

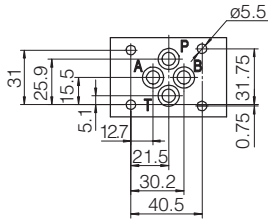

ISO 4401: 2005

Mounting surface: 4401-03-02-0-05

Fastening bolts:

4 socket head screws: M5x50 class 12.9 (DHI)
M5x30 class 12.9 (DHE)

Tightening torque = 8 Nm

Seals: 4 OR 108

Ports P,A,B,T: $\varnothing = 7.5$ mm (max)

P = PRESSURE PORT

A, B = USE PORT

T = TANK PORT

DHI-06*/FI (DC, AC)
DHI-07*/FI (DC, AC) dotted line

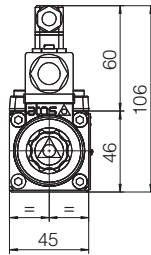
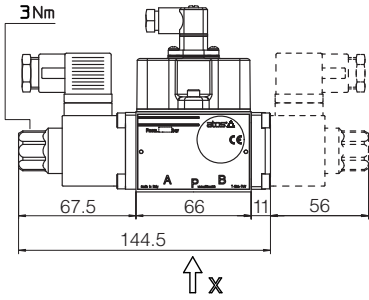

Mass:
kg 1,6 (one solenoid)
kg 1,9 (two solenoids)

option /A

Single solenoid valves: solenoid mounted at side of port B.
Double solenoid valves DHE/FV(DC): FV inductive position switch mounted at side of port A

DHI-06*/FV (DC, AC)

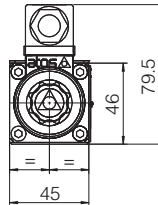
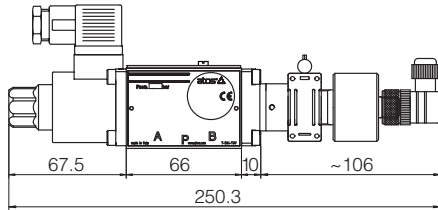

Mass: kg 1,7

DHE-06*/FI (DC)
DHE-07*/FI (DC) dotted line

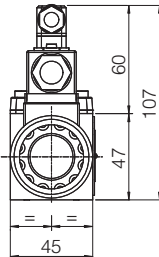
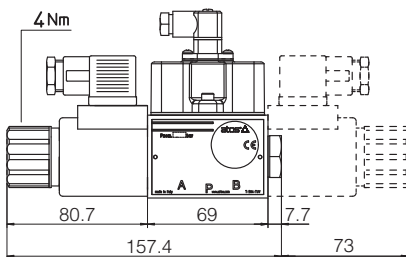

Mass:
kg 1,85 (one solenoid)
kg 2,1 (two solenoids)

DHE-06*/FI (AC)
DHE-07*/FI (AC) dotted line

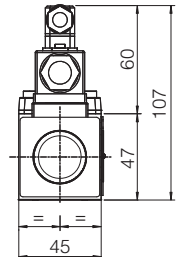
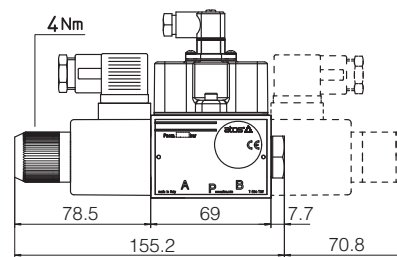

Mass:
kg 1,85 (one solenoid)
kg 2,1 (two solenoids)

DHE-06*/FV (DC)

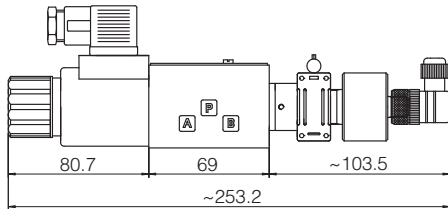

Mass: kg 1,95

DHE-06*/FV (AC)

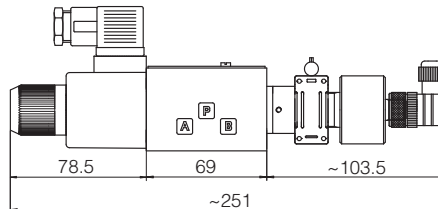

Mass: kg 1,8

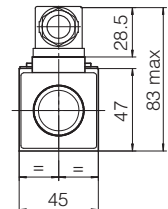

DHE-07*/FV (DC)

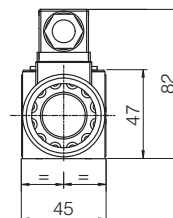
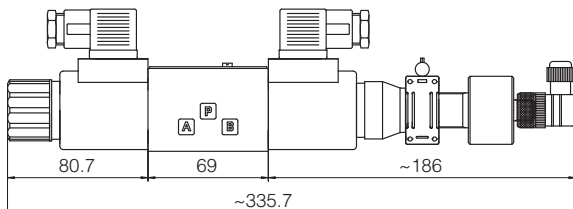

Mass: kg 2,2

17 DIMENSIONS OF DKE SOLENOID SAFETY VALVES [mm]

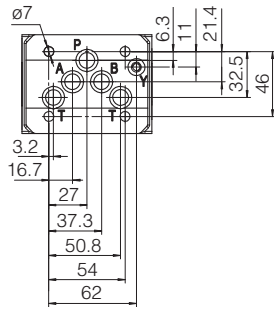

ISO 4401: 2005

Mounting surface:

4401-05-05-0-05

(without port X)

Fastening bolts:

4 socket head screws M6x40 class 12.9

Tightening torque = 15 Nm

Seals: 5 OR 2050. 1 OR 108

Ports P,A,B,T: $\varnothing = 11.5$ mm (max)

Ports Y: $\varnothing = 5$ mm

P = PRESSURE PORT

A, B = USE PORT

T = TANK PORT

Y = DRAIN PORT

option /A

Single solenoid valves: solenoid mounted at side of port B.

Double solenoid valves DKE/FV(DC): FV inductive position switch mounted at side of port A

DKE-16*/FI (DC)
DKE-17*/FI (DC) dotted line

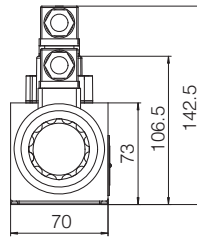
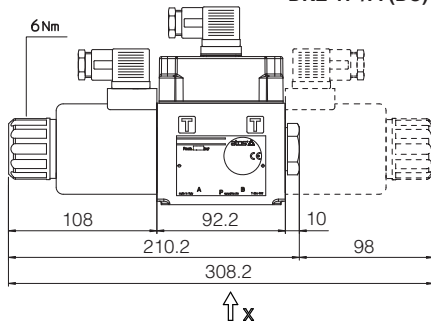

Mass:
kg 4,4 (one solenoid)
kg 5,8 (two solenoids)

DKE-16*/FI (AC)
DKE-17*/FI (AC) dotted line

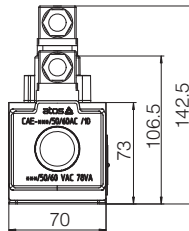
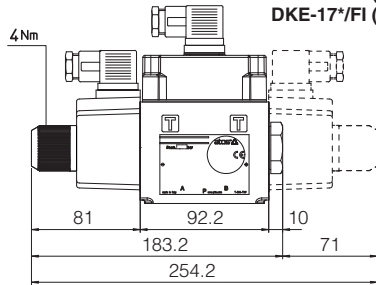

Mass:
kg 3,7 (one solenoid)
kg 4,4 (two solenoids)

DKE-16*/FV (DC)

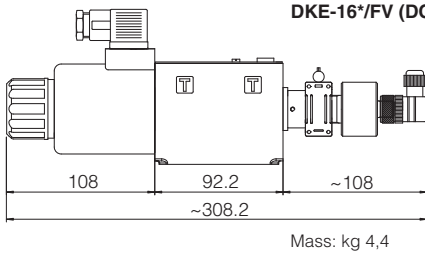

DKE-17*/FV (DC)

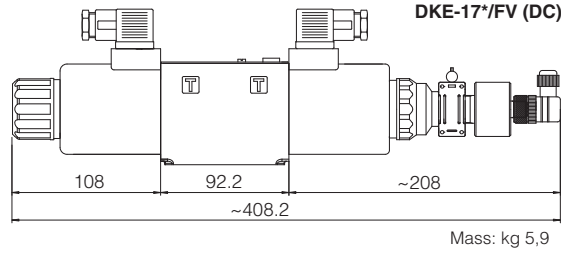

DKE-16*/FV (AC)

