

# HYDRAULIC MOTORS MH

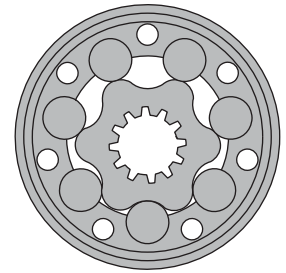

## APPLICATION

- » Conveyors
- » Feeding mechanism of robots and manipulators
- » Metal working machines
- » Textile machines
- » Agriculture machines
- » Food industries
- » Mining machinery etc.



## CONTENTS

Specification data .....	77
Function diagrams .....	78÷80
Permissible shaft loads .....	80
Dimensions and mounting .....	81
Permissible shaft seal pressure.....	82
Shaft extensions .....	83
Order code .....	83

## OPTIONS

- » Model- Spool valve, roll-gerotor
- » Flange mount
- » Shafts- straight, splined and tapered
- » Metric and BSPP ports
- » Other special features

## GENERAL

<b>Max. Displacement,</b> cm <sup>3</sup> /rev [in <sup>3</sup> /rev]	502,4 [30.7]
<b>Max. Speed,</b> [RPM]	445
<b>Max. Torque,</b> daNm [lb-in]	cont.: 84 [7434] int.: 104 [9204]
<b>Max. Output,</b> kW [HP]	18,5 [24.8]
<b>Max. Pressure Drop,</b> bar [PSI]	cont.: 175 [2540] int.: 200 [2900]
<b>Max. Oil Flow,</b> lpm [GPM]	90 [23.78]
<b>Min. Speed,</b> [RPM]	5
<b>Pressure fluid</b>	Mineral based- HLP(DIN 51524) or HM(ISO 6743/4)
<b>Temperature range,</b> °C [°F]	-40÷140 [-40÷284]
<b>Optimal Viscosity range,</b> mm <sup>2</sup> /s [SUS]	20÷75 [98÷347]
<b>Filtration</b>	ISO code 20/16 (Min. recommended fluid filtration of 25 micron)

### Oil flow in drain line

Pressure drop bar [PSI]	Viscosity mm <sup>2</sup> /s [SUS]	Oil flow in drain line lpm [GPM]
100 [1450]	20 [98]	2,5 [.660]
	35 [164]	1,8 [.476]
140 [2030]	20 [98]	3,5 [.925]
	35 [164]	2,8 [.740]

### Pressure Losses

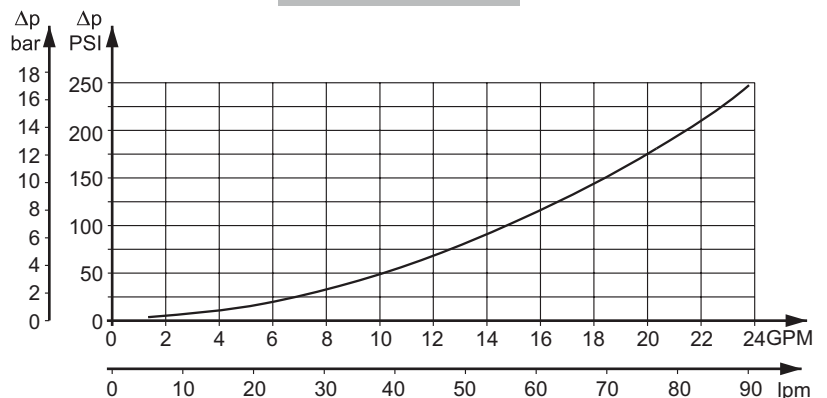

## SPECIFICATION DATA

Type	MH 200	MH 250	MH 315	MH 400	MH 500	
<b>Displacement, cm<sup>3</sup>/rev [in<sup>3</sup>/rev]</b>	201,3 [12.3]	252 [15.4]	314,9 [16.4]	396,8 [24.2]	502,4 [30.7]	
<b>Max. Speed, [RPM]</b>	Cont.	370	295	235	185	150
	Int.*	445	350	285	225	180
<b>Max. Torque daNm [in-lb]</b>	Cont.	51 [4510]	61 [5398]	74 [6548]	84 [7434]	82 [7257]
	Int.*	58 [5130]	70 [6195]	82 [7257]	98 [8673]	104 [9204]
	Peak**	64 [5064]	79 [6992]	98 [8673]	109 [9647]	117 [10350]
<b>Max. Output kW [HP]</b>	Cont.	16 [21]	16 [21]	14 [18.7]	12,5 [16.7]	11 [14.7]
	Int.*	18,5 [24.8]	18,5 [24.8]	15,5 [20.7]	15 [20.1]	14 [18.7]
<b>Max. Pressure Drop bar [PSI]</b>	Cont.	175 [2540]	175 [2540]	175 [2540]	155 [2240]	125 [1810]
	Int.*	200 [2900]	200 [2900]	200 [2900]	190 [2750]	160 [2320]
	Peak**	225 [3260]	225 [3260]	225 [3260]	210 [3045]	180 [2610]
<b>Max. Oil Flow lpm [GPM]</b>	Cont.	75 [20]	75 [20]	75 [20]	75 [20]	75 [20]
	Int.*	90 [24]	90 [24]	90 [24]	90 [24]	90 [24]
<b>Max. Inlet Pressure bar [PSI]</b>	Cont.	200 [2900]	200 [2900]	200 [2900]	200 [2900]	200 [2900]
	Int.*	225 [3260]	225 [3260]	225 [3260]	225 [3260]	225 [3260]
	Peak**	250 [3626]	250 [3626]	250 [3626]	250 [3626]	250 [3626]
<b>Max. Starting Pressure with Unloaded Shaft, bar [PSI]</b>	5 [72]	5 [72]	5 [72]	5 [72]	5 [72]	
<b>Min. Starting Torque, daNm [in-lb]</b>	At max.press.dropCont	39 [3450]	52 [4600]	66 [5840]	72 [6370]	72 [6370]
	At max.press.drop Int.*	45 [3980]	59 [5221]	73 [6460]	88 [7788]	88 [7788]
<b>Min. Speed***, [RPM]</b>	10	10	8	5	5	
<b>Weight, kg [lb]</b>	10,5 [23.2]	11 [24.3]	11,5 [25.4]	12,3 [27.1]	13 [28.7]	

\* Intermittent operation: the permissible values may occur for max. 10% of every minute.

\*\* Peak load: the permissible values may occur for max. 1% of every minute.

\*\*\* For speeds lower than given, consult factory or your regional manager.

1. Intermittent speed and intermittent pressure must not occur simultaneously.
2. Recommended filtration is per ISO cleanliness code 20/16. A nominal filtration of 25 micron or better.
3. Recommend using a premium quality, anti-wear type mineral based hydraulic oil HLP(DIN51524) or HM ( ISO 6743/4).  
If using synthetic fluids consult the factory for alternative seal materials.
4. Recommended minimum oil viscosity 13 mm<sup>2</sup>/s [70 SUS] at 50°C [122°F].
5. Recommended maximum system operating temperature is 82°C [180°F].
6. To assure optimum motor life fill with fluid prior to loading and run at moderate load and speed for 10-15 minutes.

**FUNCTION DIAGRAMS**

**MH 200**

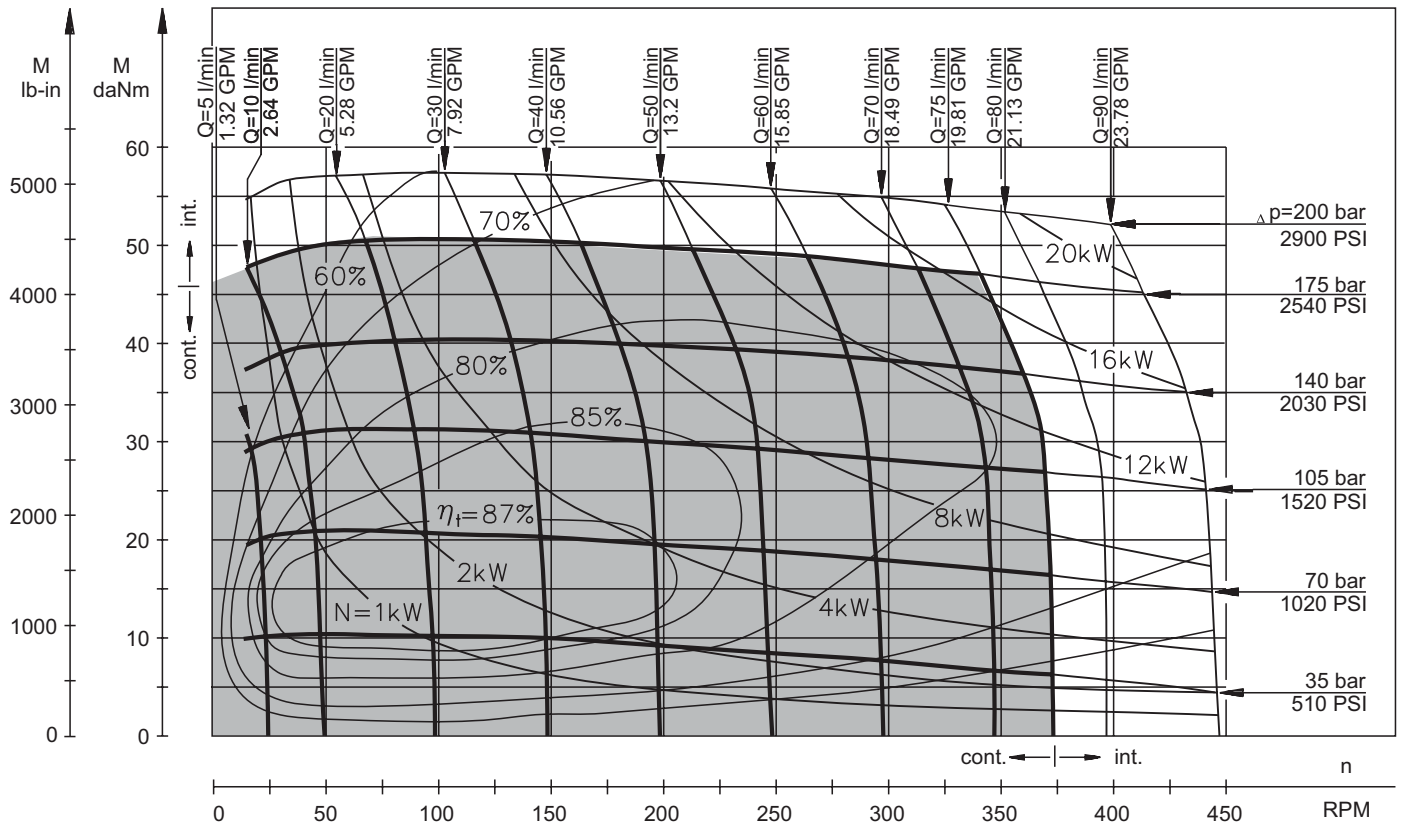

**MH 250**

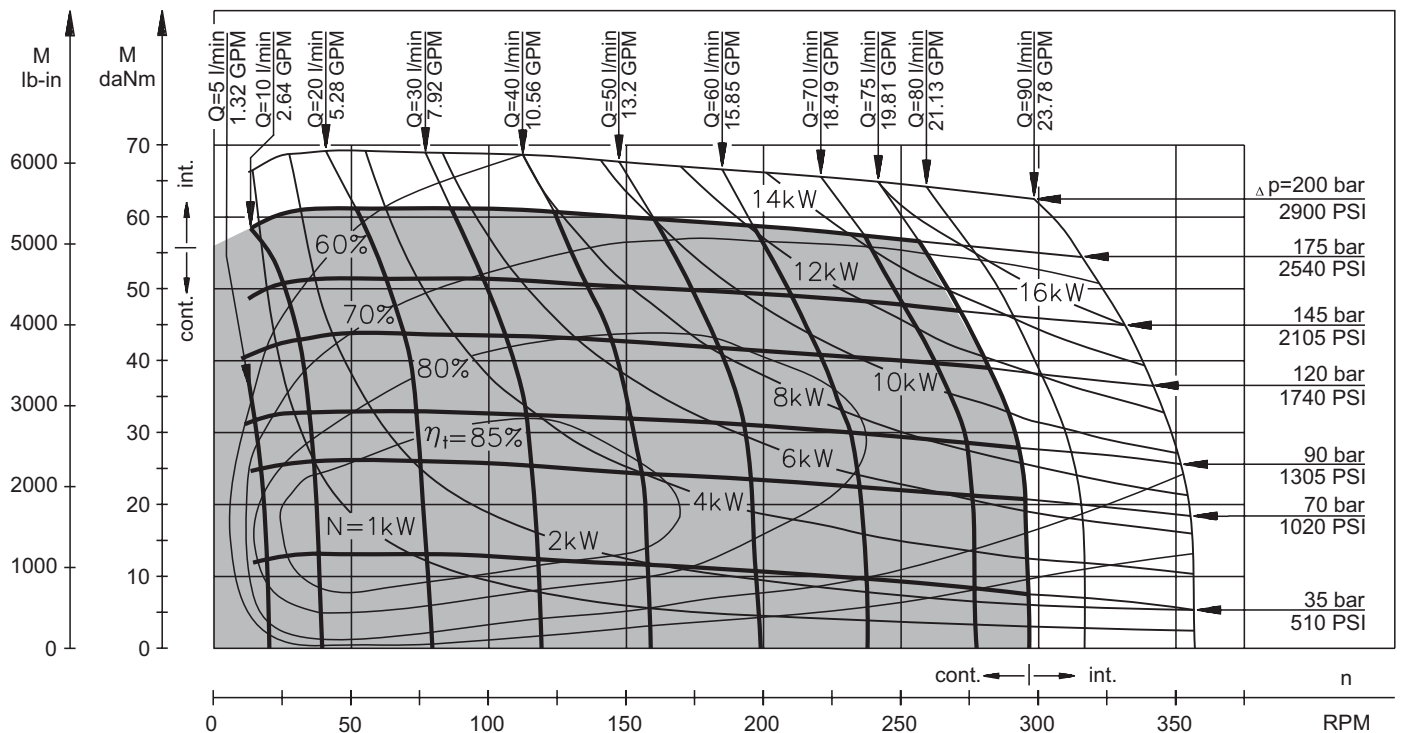

The function diagrams data is for average performance of randomly selected motors at back pressure  $5 \div 10$  bar [72.5 ÷ 145 PSI] and oil with viscosity of  $32 \text{ mm}^2/\text{s}$  [150 SUS] at  $50^\circ\text{C}$  [122°F].

**FUNCTION DIAGRAMS**

**MH 315**

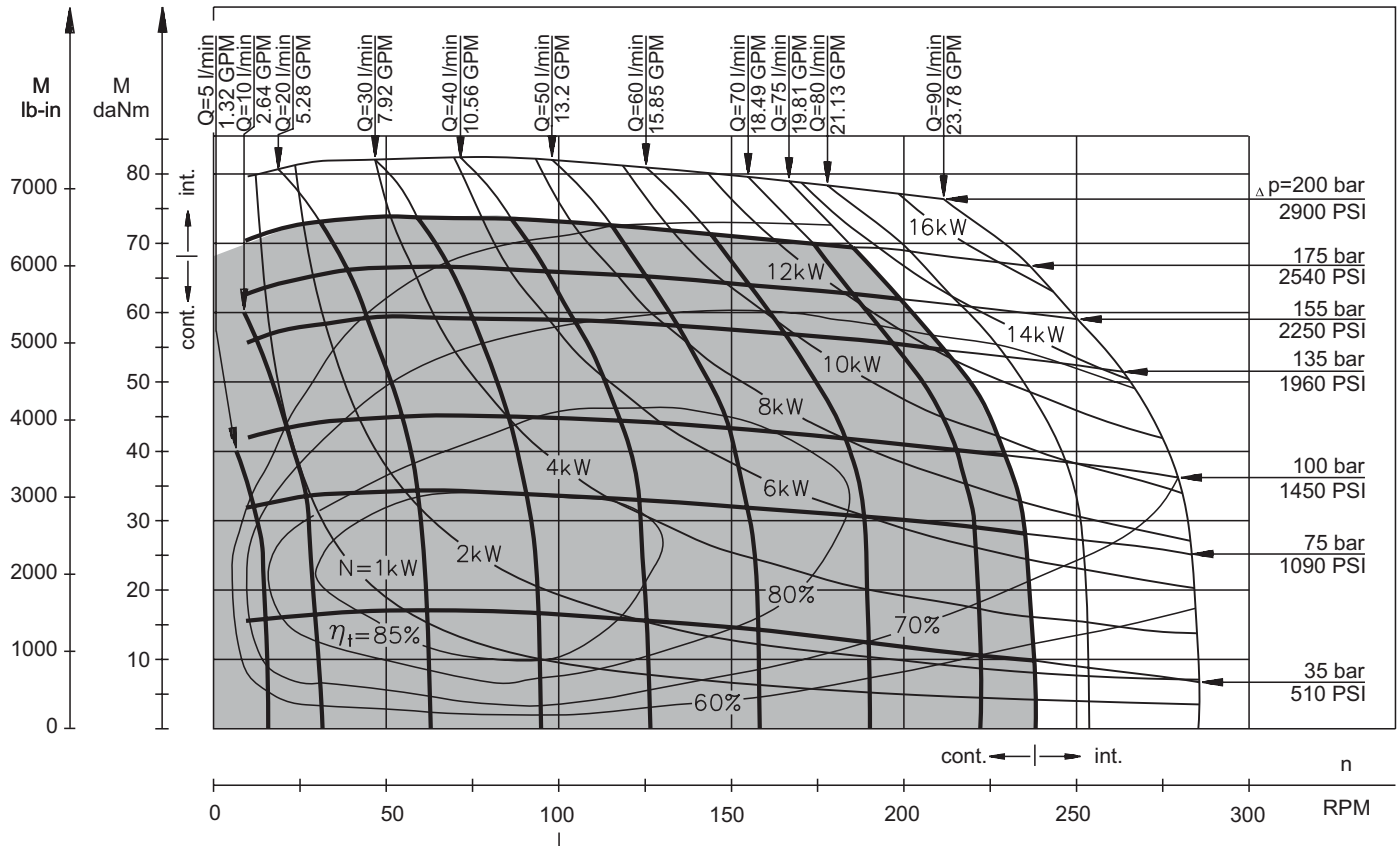

**MH 400**

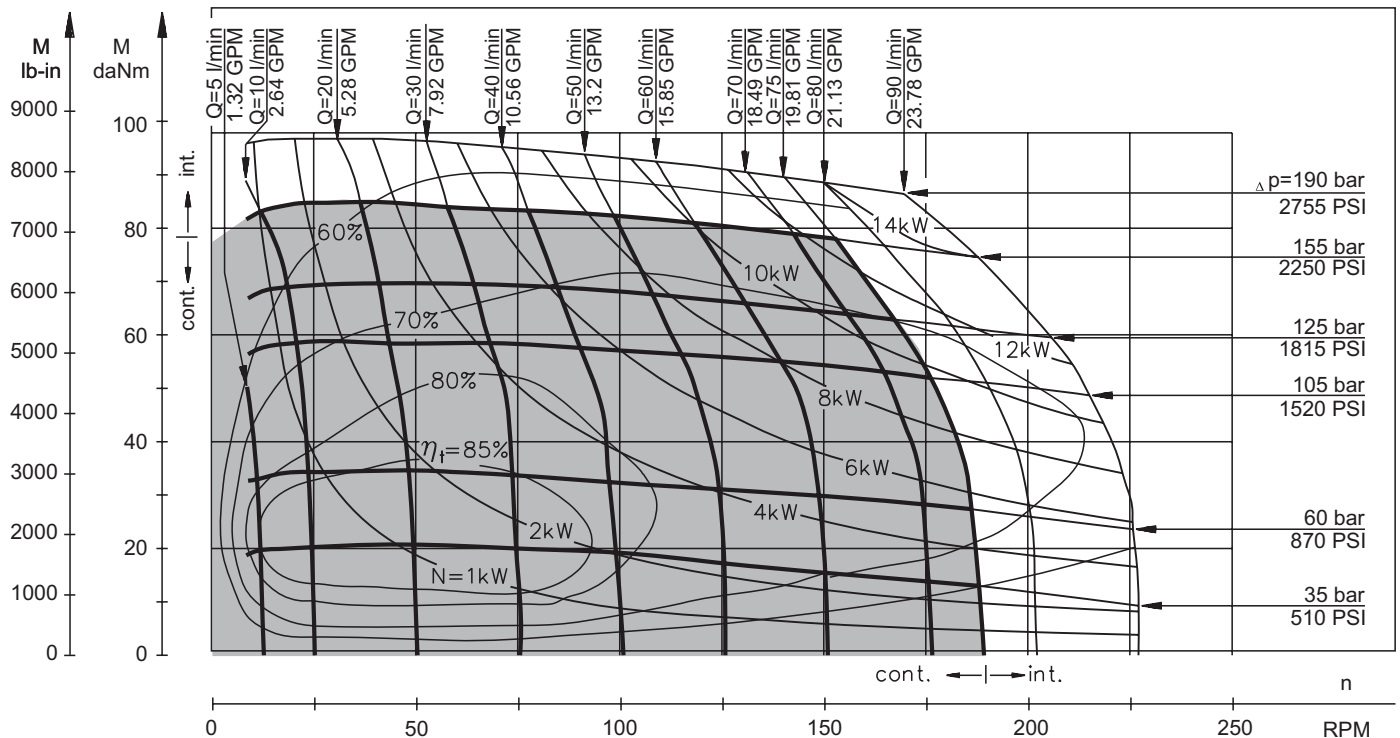

The function diagrams data is for average performance of randomly selected motors at back pressure 5÷10 bar [72.5÷145 PSI] and oil with viscosity of 32 mm<sup>2</sup>/s [150 SUS] at 50°C [122°F].

## FUNCTION DIAGRAMS

### MH 500

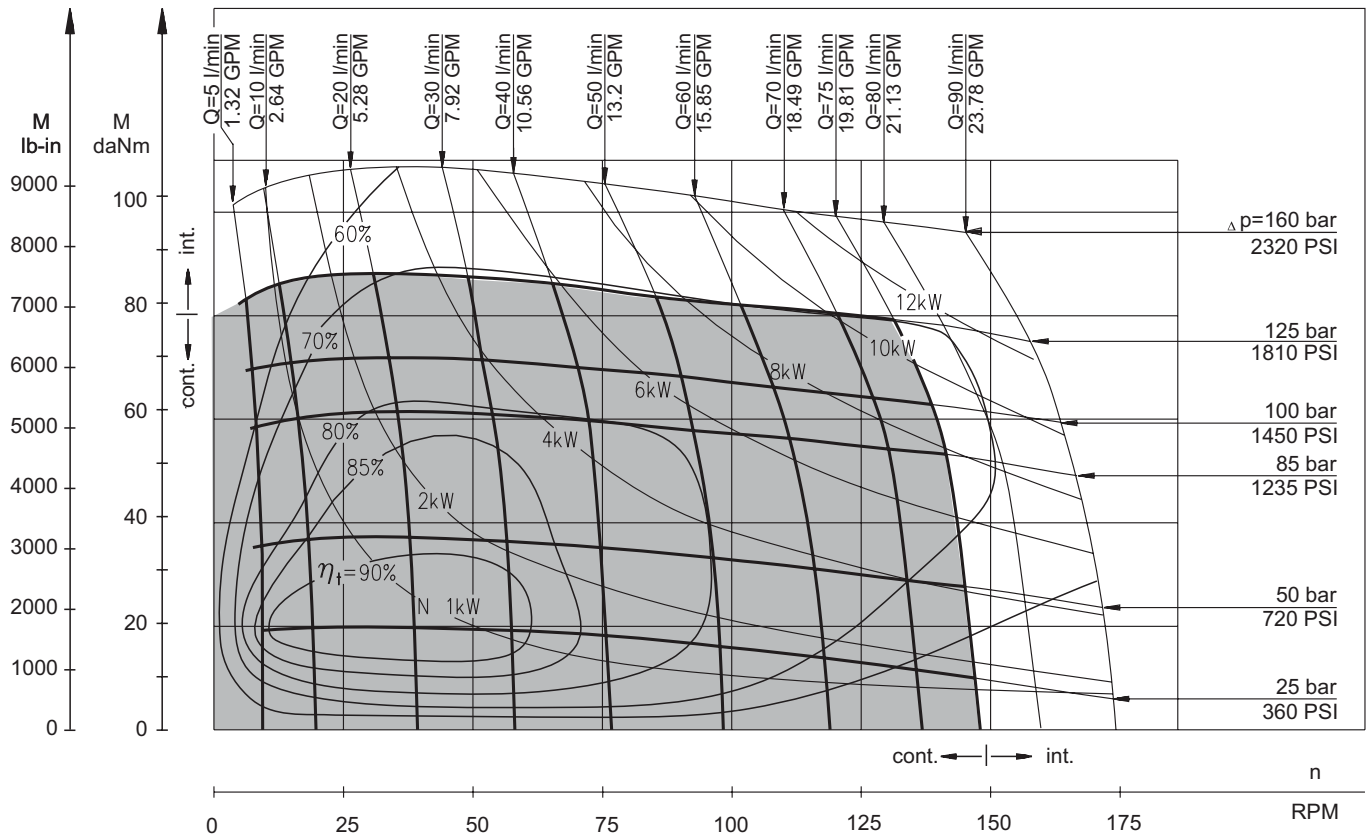

The function diagrams data is for average performance of randomly selected motors at back pressure 5÷10 bar [72.5÷145 PSI] and oil with viscosity of 32 mm<sup>2</sup>/s [150 SUS] at 50°C [122°F].

### PERMISSIBLE SHAFT LOADS FOR MH MOTORS

The permissible radial shaft load  $P_{rad}$  depends on the speed (RPM) and distance (L) from the point of load to the mounting flange.

$$Radial\ Shaft\ Load\ P_{rad} = \frac{1100}{n} \times \frac{25000}{103,5+L}, daN^*$$

[\*L in mm; L ≤ 60 mm; n ≥ 200 RPM]

$$Radial\ Shaft\ Load\ P_{rad} = \frac{1100}{RPM} \times \frac{2215}{4.075+L}, lbs^{**}$$

[\*\*L in inch; L ≤ 2.36 in; n ≥ 200 RPM]

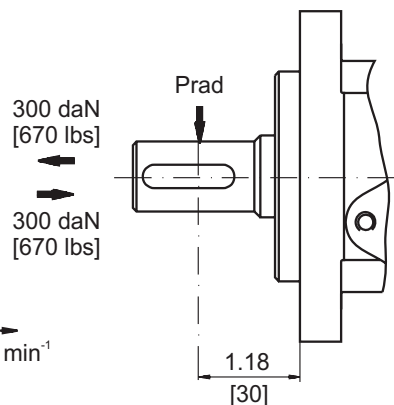
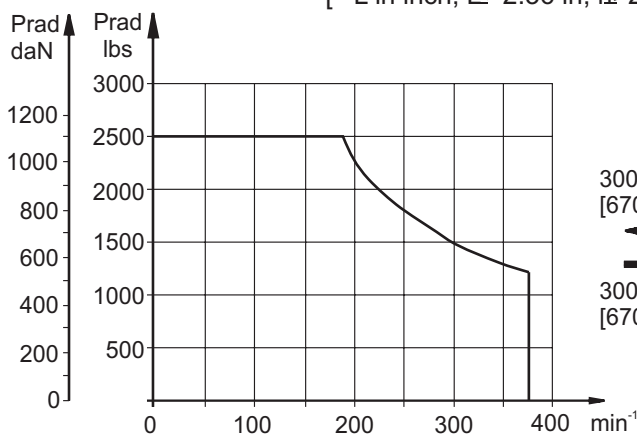

## DIMENSIONS AND MOUNTING DATA

### Magneto Maunt (4 holes)

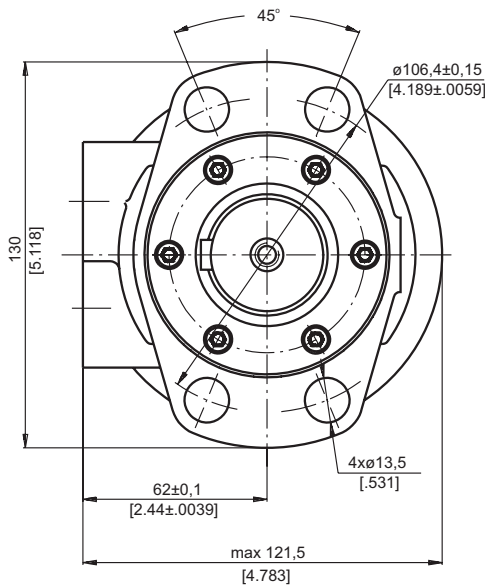
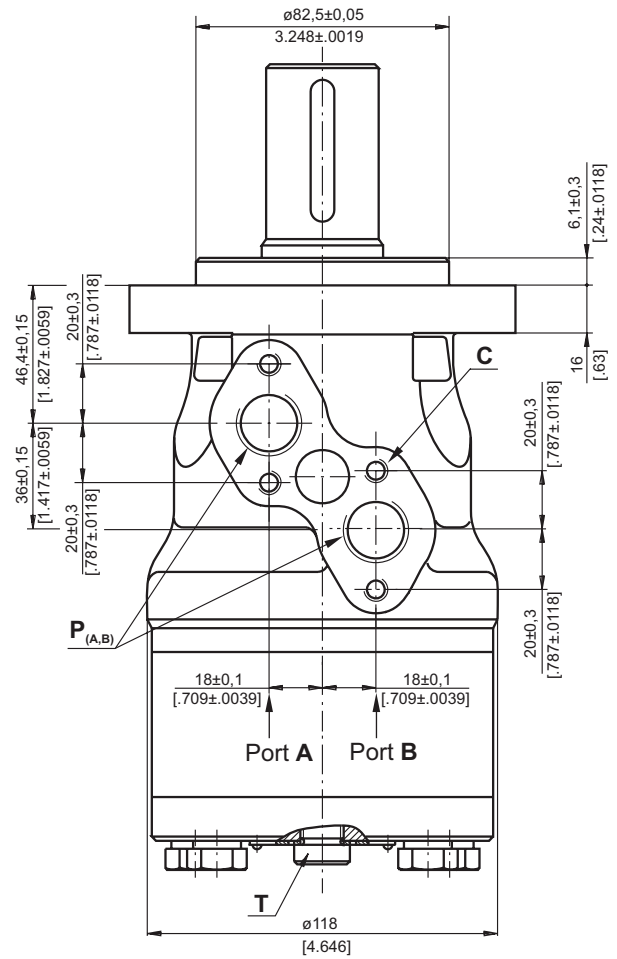
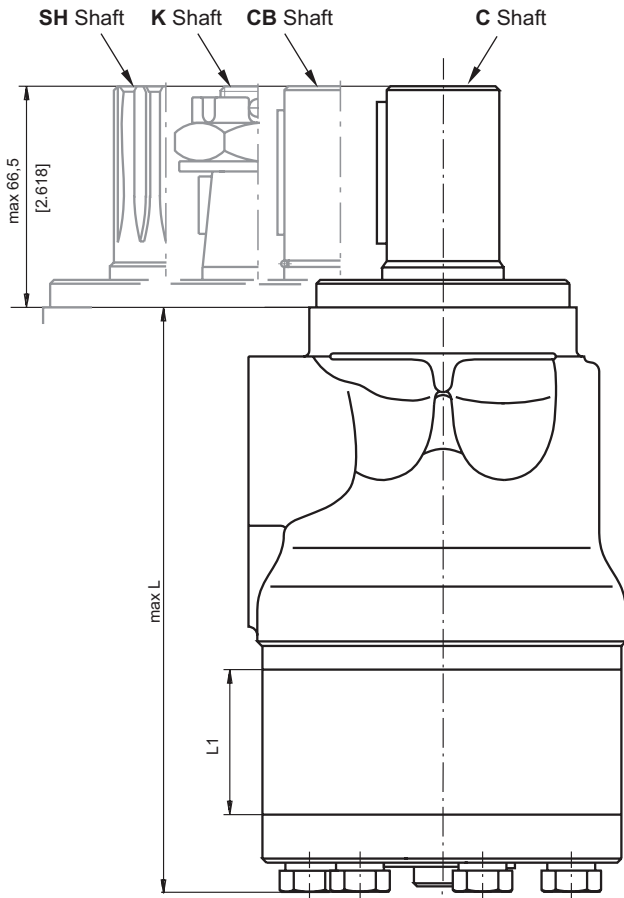

Type	L, mm [in.]	L <sub>1</sub> , mm [in.]
MH 200	169 [6.65]	27,8 [1.09]
MH 250	176 [6.93]	34,8 [1.37]
MH 315	184 [7.24]	43,5 [1.71]
MH 400	196 [7.72]	54,8 [2.16]
MH 500	211 [8.31]	69,4 [2.73]

- C** : 4xM8-13 mm [.51 in] depth  
**P<sub>(A,B)</sub>** : 2xG1/2 or 2xM22x1,5-15 mm [.59 in] depth  
**T** : G1/4 or M14x1,5-12 mm [.47 in] depth (plugged)

**Standard Rotation**  
 Viewed from Shaft End  
 Port A Pressurized - CW  
 Port B Pressurized - CCW

**Reverse Rotation**  
 Viewed from Shaft End  
 Port A Pressurized - CCW  
 Port B Pressurized - CW



**MAX. PERMISSIBLE SHAFT SEAL PRESSURE FOR MH MOTORS**

**MH...U1 motors with high pressure seal and without drain connection:**

The shaft seal pressure equals the average of input pressure and return pressure.

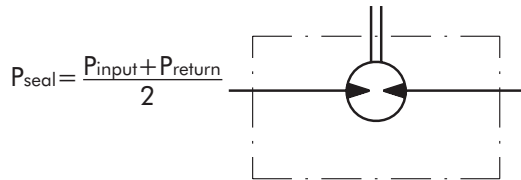

**MH...U motors with high pressure seal and drain connection:**

The shaft seal pressure equals the pressure in the drain line.

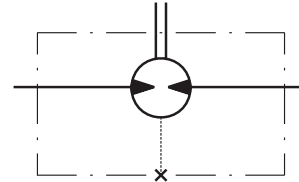

**MH...1 motors with standard shaft seal and without drain connection:**

The shaft seal pressure never exceeds the pressure in the return line.

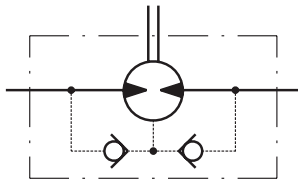

**MH... motors with standard shaft seal and with drain connection:**

The shaft seal pressure equals the pressure in the drain line.

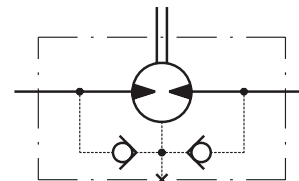

**Max. return pressure without drain line or max. pressure in the drain line**

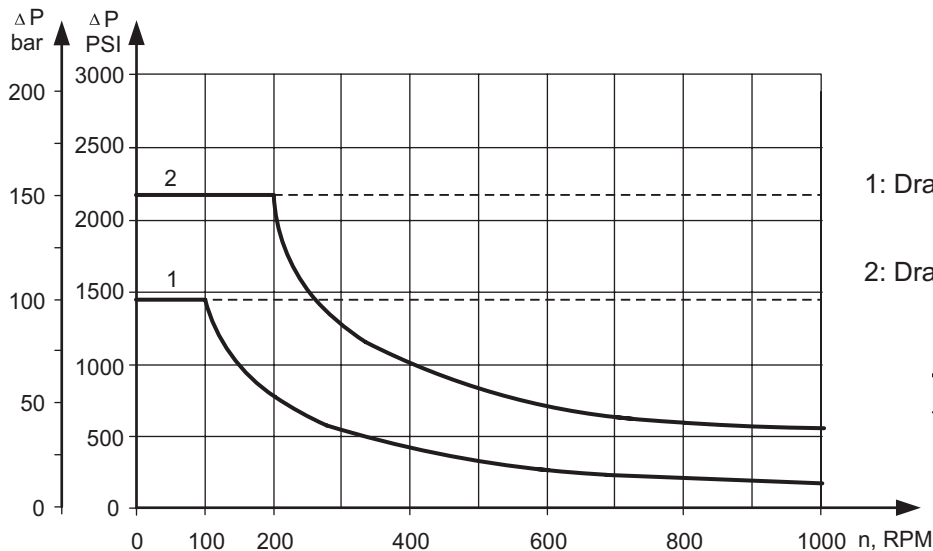

1: Drawing for Standard Shaft Seal

2: Drawing for High Pressure Seal ("U" Seal)

— - continuous operations

- - - - intermittent operations

**SHAFT EXTENSIONS**

**C** -  $\varnothing 32$  straight, Parallel key A10x8x45 DIN 6885  
Max. Torque 77 daNm [6815 lb-in]

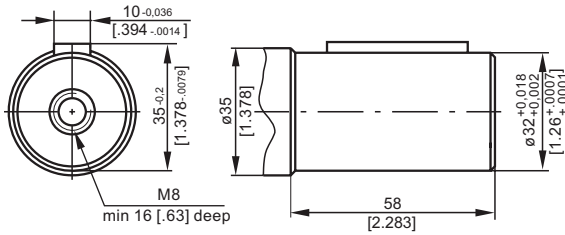

**SH** -  $\varnothing 1\frac{1}{4}$ " splined 14T, DP 12/24 ANSI B92.1-1976  
Max. Torque 95 daNm [8400 lb-in]

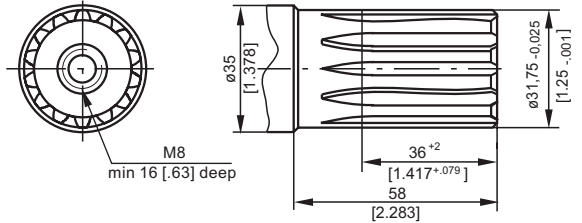

**CB** -  $\varnothing 35$  straight, Parallel key A10x8x45 DIN 6885  
Max. Torque 95 daNm [8400 lb-in]

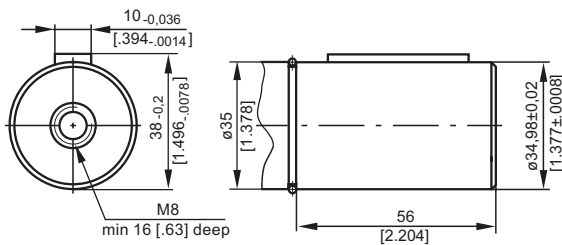

**K** - tapered 1:10, Parallel key B6x6x20 DIN 6885  
Max. Torque 95 daNm [8400 lb-in]

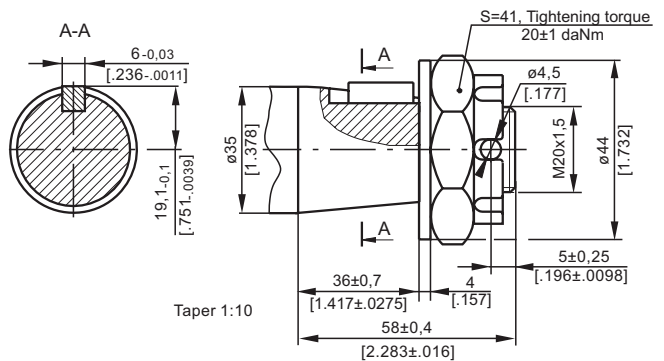

**ORDER CODE**



	1	2	3	4	5	6	7
<b>MH</b>							

Pos. 1	Displacement code
<b>200</b>	- 201,3 cm <sup>3</sup> /rev [12.3 in <sup>3</sup> /rev]
<b>250</b>	- 252,0 cm <sup>3</sup> /rev [15.4 in <sup>3</sup> /rev]
<b>315</b>	- 314,9 cm <sup>3</sup> /rev [16.4 in <sup>3</sup> /rev]
<b>400</b>	- 396,8 cm <sup>3</sup> /rev [24.2 in <sup>3</sup> /rev]
<b>500</b>	- 502,4 cm <sup>3</sup> /rev [30.7 in <sup>3</sup> /rev]
Pos. 2	Shaft Extensions *
<b>C</b>	- $\varnothing 32$ straight, Parallel key A10x8x45 DIN 6885
<b>SH</b>	- $\varnothing 1\frac{1}{4}$ " splined 14T ANSI B92.1-1970
<b>CB**</b>	- $\varnothing 35$ straight, Parallel key A10x8x45 DIN 6885
<b>K</b>	- $\varnothing 35$ tapered 1:10, Parallel key B6x6x20 DIN 6885

Pos. 3	Shaft Seal Version
omit	- Standard shaft seal
<b>U</b>	- High pressure shaft seal (without check valves)
Pos. 4	Drain Port
omit	- with drain port
<b>1</b>	- without drain port
Pos. 5	Ports
omit	- BSPP (ISO 228)
<b>M</b>	- Metric (ISO 262)
Pos. 6	Special Features (see page 98)
Pos. 7	Design Series
omit	- Factory specified

**NOTES:** \* The permissible output torque for shafts must not be exceeded!

\*\* The following combination is not allowed: "CB" shaft with U shaft seal.

The hydraulic motors are mangano-phosphatized as standard.